



12'x14' Garden Shed Plan

Compare our Free vs. Premium plan

This perfectly designed plan will guide you through the entire process of building your very own shed for any backyard or garden.



Check out the benefits you would get with our **premium edition**:

Features	Free plan	Premium edition
Steps count	12	32
Illustrations for Each Step	✓	✓
Print Ready	✓	✓
Step By Step Instructions	✓	✓
Full Materials and Cuttings List	✗	✓
Additional Illustrations	✗	✓
Additional Blueprints	✗	✓
Tools List	✗	✓
Fastening Elements List	✗	✓
Technical Support	✗	✓

BUY NOW

12'x14' garden shed material list

Site Preparation

- Concrete
- Bricks

Bottom Frame

- Pressure-Treated Lumber
- Plywood

Walls Frames

- Pressure-Treated Lumber

Shed's Roof

- Pressure-Treated Lumber
- Pressure-Treated Board
- Plywood
- Building paper
- Asphalt shingles
- Metal drip edge

Front/Side Shed's Window

- Pressure-Treated Lumber
- Window beading
- Glass

Walls Exterior Siding

- Pressure-Treated Lumber
- Wood siding boards

Top Frame

- Pressure-Treated Lumber

Fasteners & Hardware

- Corner braces
- Galvanized nails
- Wood screws

STEP 1

Foundation Preparation

1.1 Fill the trenches to ground level with concrete and let cure, or harden. Since curing times vary between brands, read the packaging for recommended curing times.

1.2 Once the concrete has cured, use standard-sized bricks and lay them across the foundation. You will need roughly 254 bricks for this step.

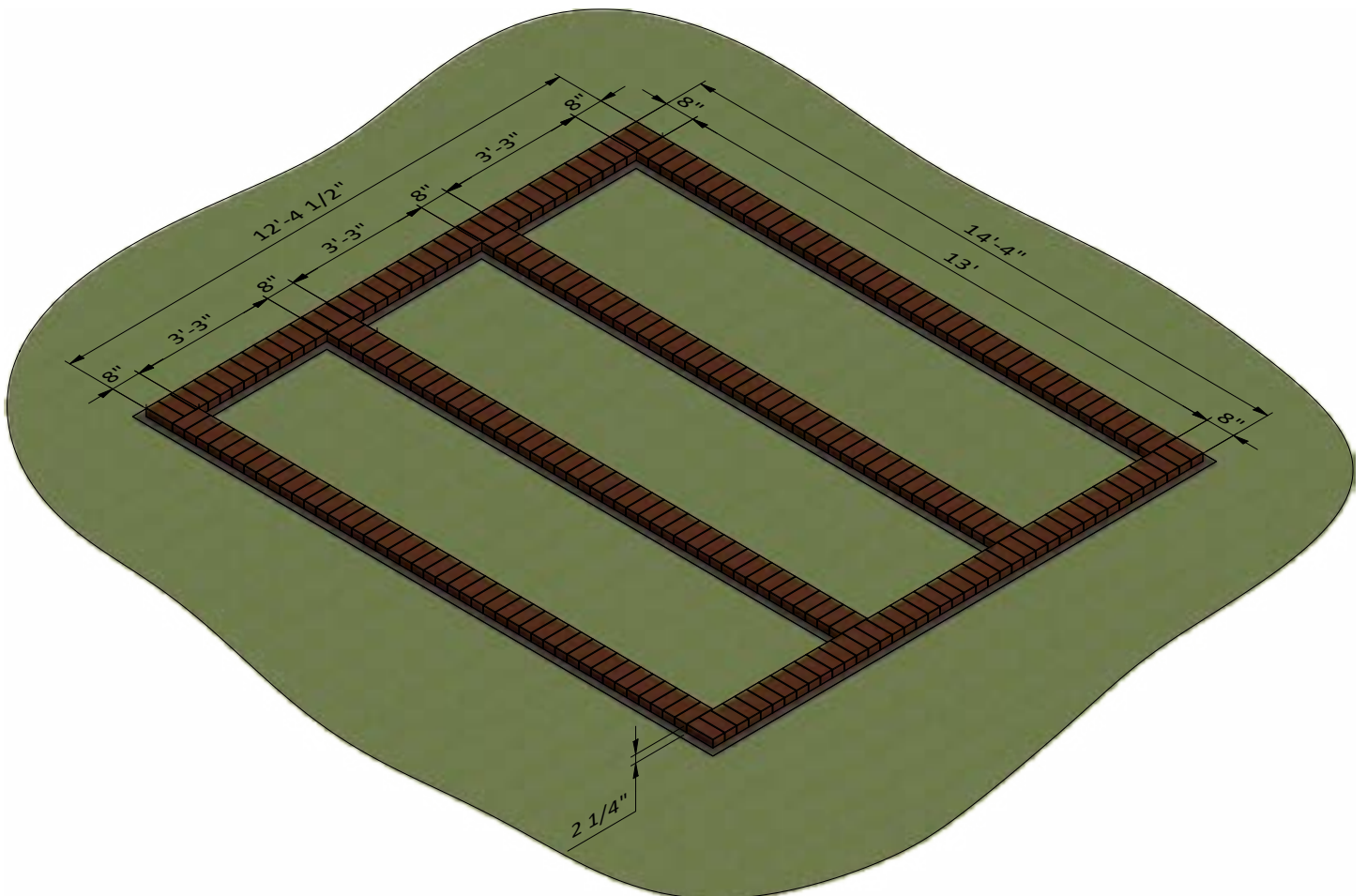
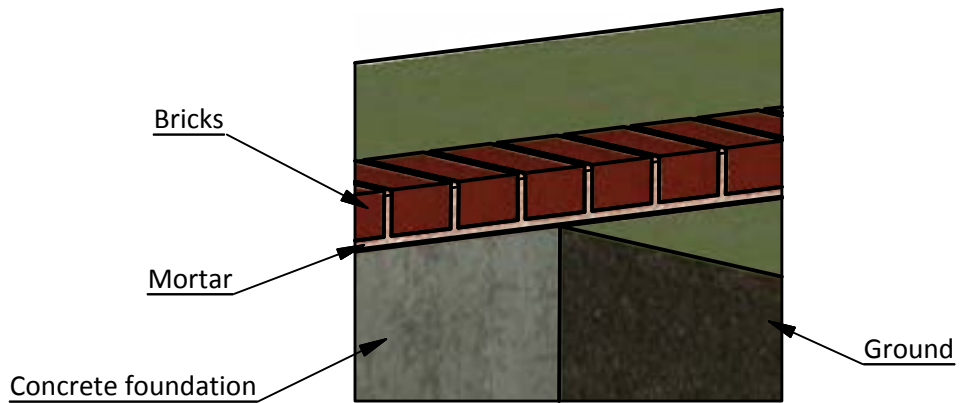

STEP 2

Framing the Floor

2.1 Assemble the frame using 1 1/2" x 7 1/4" pressure-treated lumber. You will need ten boards cut to 11'-6 1/4" that will be the joist.

2.2 Secure the beams with 8x3" wood screws.

2.3 Using a speed square or carpenter's square, check the corners to make sure they are 90°.

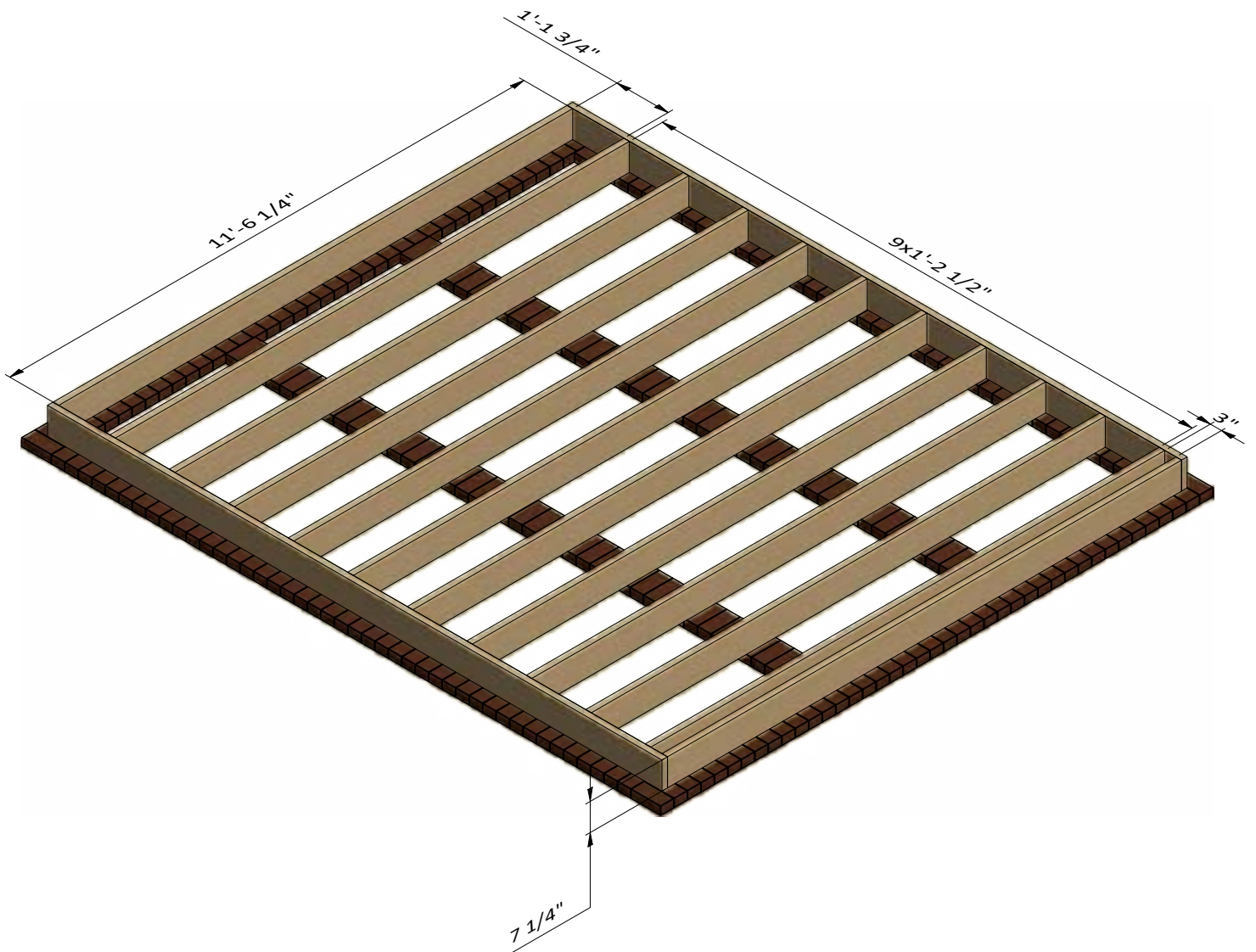

STEP 3

Assemble Front Wall Frame

3.1 Using $1\frac{1}{2}'' \times 3\frac{1}{2}''$, $1\frac{1}{2}'' \times 7\frac{1}{4}''$ and $3\frac{1}{2}'' \times 3\frac{1}{2}''$ pressure-treated lumber, construct front wall frame using the drawing below as a reference. You will need eight boards cut to $6'-11''$, two boards cut to $5'-10\frac{1}{2}''$ that will be studs, two boards cut to $4'-2\frac{3}{4}''$ that will be the bottom plates, one board cut to $13'-9\frac{1}{4}''$ that will be the top plate, two boards cut to $5'-7''$ that will be the door header and five boards cut to $5\frac{1}{4}''$ that will be cripple studs.

3.2 Connect the beams with $2 \times 3''$ and $2 \times 5''$ wood screws.

3.3 Using a speed square or carpenter's square, check the corners to make sure they are 90° .

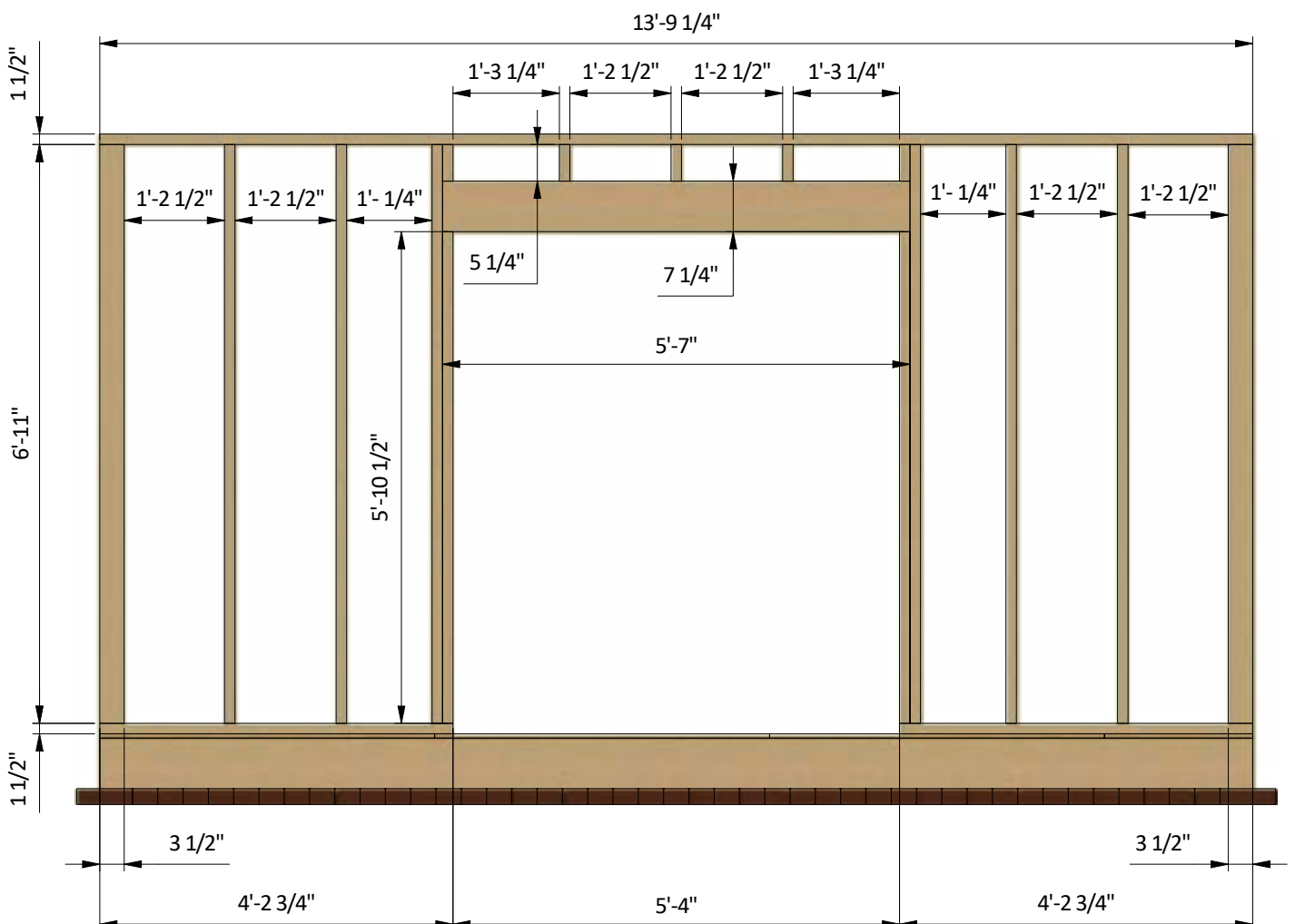

STEP 4

Assemble Back Wall Frame

4.1 Using 1 1/2" x 3 1/2" and 3 1/2" x 3 1/2" pressure-treated lumber, construct back wall frame using the drawing below as a reference. You will need twelve boards cut to 6'-11" that will be the studs and two boards cut to 13'-9 1/4" that will be the top and bottom plates.

4.2 Connect the beams with 2x3" wood screws.

4.3 Using a speed square or carpenter's square, check the corners to make sure they are 90°.



STEP 5

Assemble Side Wall Frames

5.1 Using 1 1/2" x 3 1/2" and 1 1/2" x 5 1/2" pressure-treated lumber, construct side wall frames using the drawing below as a reference. For each side wall you will need two boards cut to 3'-7" that will be the window header, one board cut to 3'-4" that will be rough sill, eight boards cut to 6'-11", two boards cut to 6'-5 1/2" and two boards cut to 3' that will be the studs and two boards cut to 11'-2 1/4" that will be the top and bottom plates.

5.2 Connect the beams with 2x3" wood screws.

5.3 Using a speed square or carpenter's square, check the corners to make sure they are 90°.

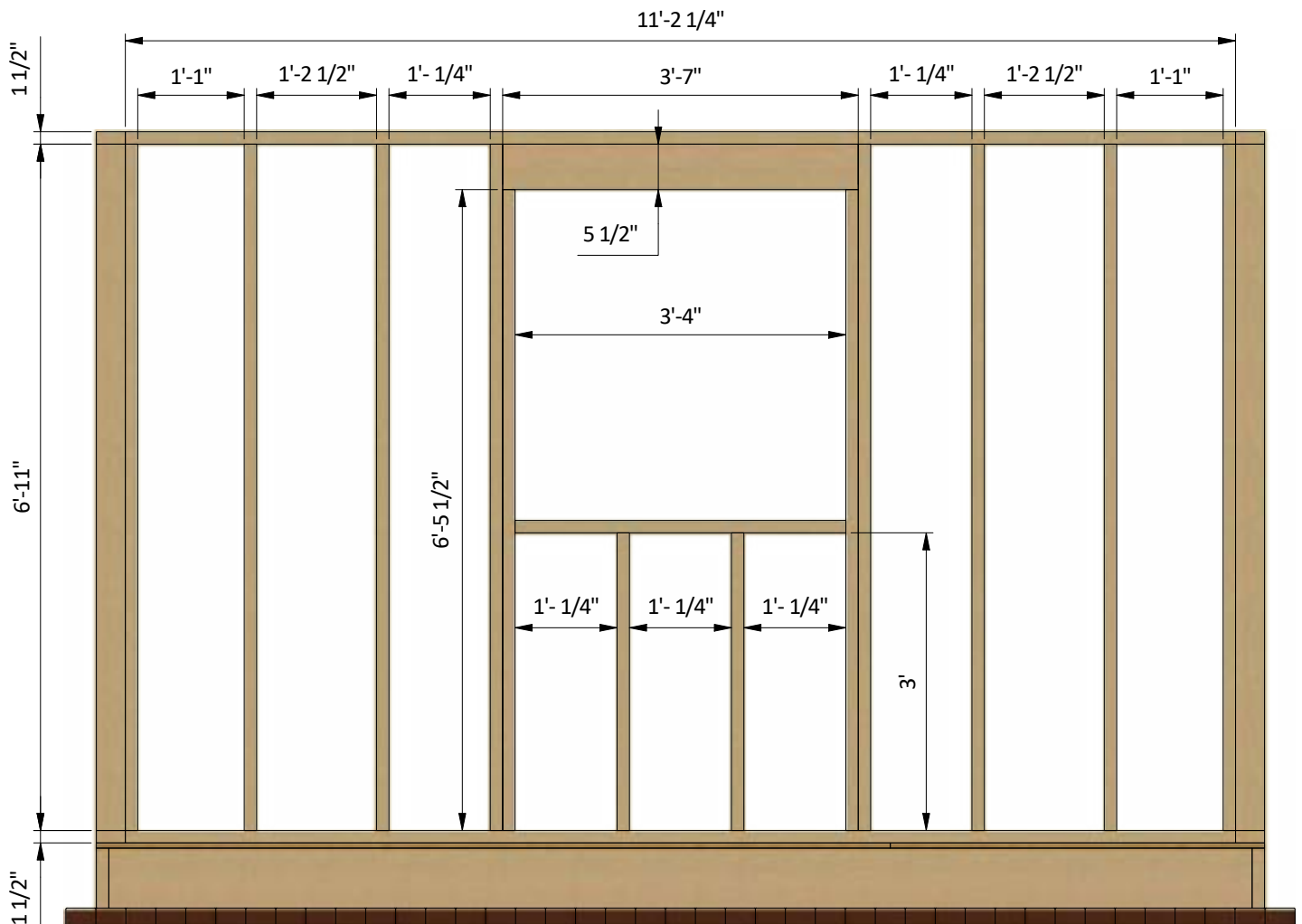

STEP 6

Assemble the Roof Frame

6.1 Using 1 1/2" x 5 1/2" pressure-treated lumber, cut twenty four rafters 7'-4 3/4" long according to the dimensions in drawings below.

6.2 Using 1 1/2" x 3 1/2" pressure-treated lumber, cut ten collar ties 5'-4" long according to the dimensions in drawings below.

6.3 Using 1 1/2" x 5 1/2" pressure-treated board, cut one board 6" long, one board 10 3/4" and nine boards cut to 1'-2 1/2" long that will be ridge boards according the illustration below.

6.4 Connect the beams with 3" and 5" wood screws.

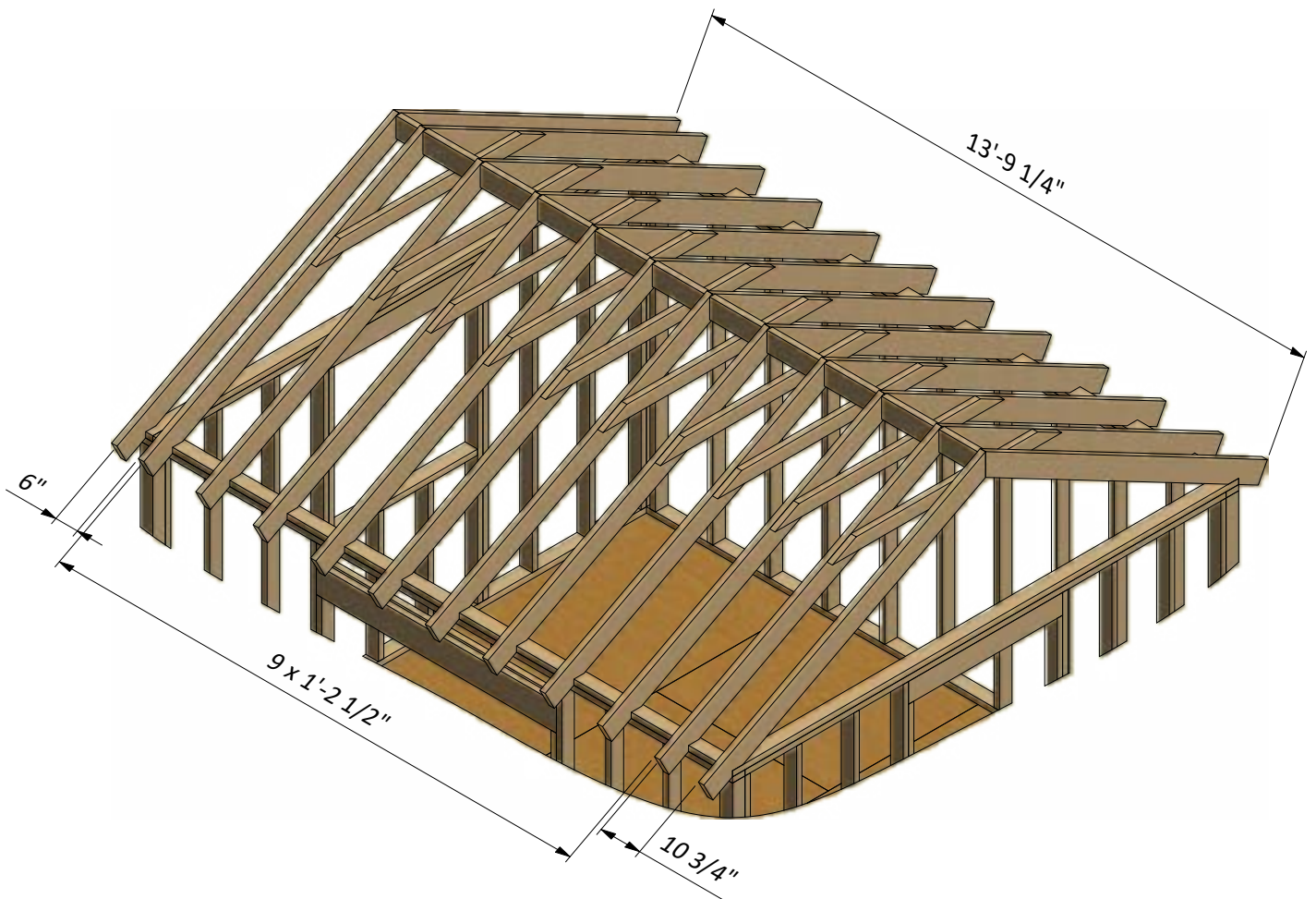

STEP 7

Assemble and Install Shed Doors

7.1 Build the door frames for the shed using 1 1/2" x 3 1/2" pressure-treated lumber and secure with 5" wood screws. You will need two boards cut to 5'-4 3/4" that will be the vertical girts, two boards cut to 2'-7 3/4" that will be the horizontal girts, two boards cut to 3'-3 1/4" that will be cross braces and one board cut to 2'-3/4" that will be middle girt.

7.2 Prepare the 5/8" plywood sheet with dimensions 5'-11 3/4" x 2'-7 3/4" for the doors according to the drawing.

7.3 Use 3/4" x 2 1/2" pressure-treated lumber for the door trim and fasten with 2" wood screws. You will need two boards cut to 5'-11 3/4" and two boards cut to 2'-2 3/4".

7.4 Using 1/4" x 3/4" pressure-treated lumber, cut and install a starter course 2'-2 3/4" long.

7.5 For the exterior siding on the door, use 1/2" x 6" wood siding boards and the illustration below as a reference. Assemble siding shields with 2" galvanized nails.

7.6 Install three 4" door hinges using 6x1" wood screws. Finish the doors installation by attaching 4" surface bolts and 6" door pulls (see nodes H, I, G).

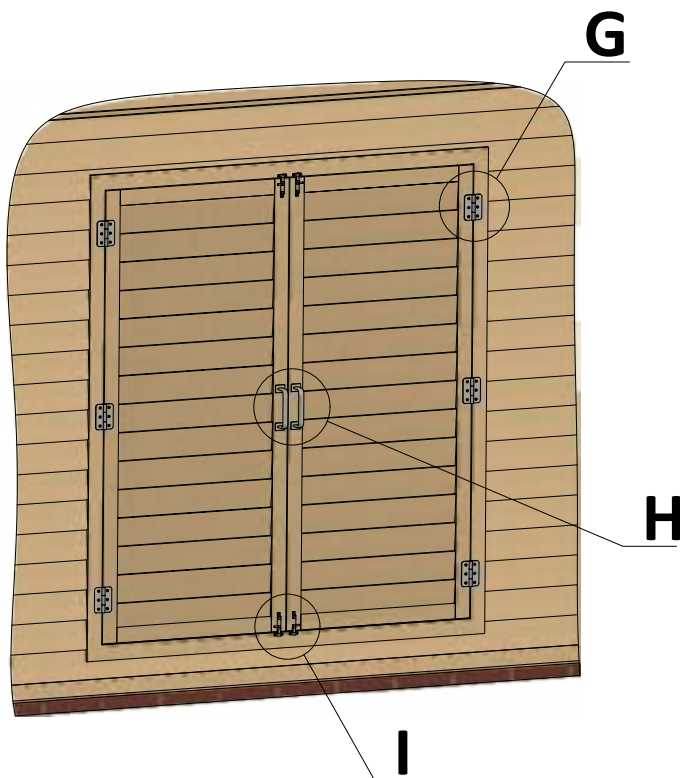

G (1 : 10)

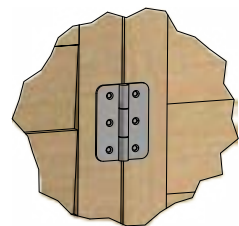

H (1 : 10)

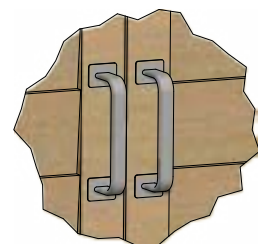

I (1 : 10)

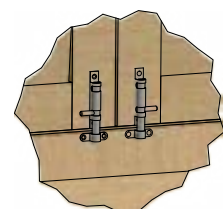

STEP 8

Window Installation for the Left and Right Walls

It is necessary to prepare 2 windows.

8.1 Using 1 1/2" x 2 1/2" pressure-treated lumber, assemble the outer frame for the window as shown in the drawing below. You will need four boards cut to 3'-3 1/2" that will be the vertical and horizontal girts. Cut the recesses in each beam for splicing connection and mill a recess for the glass.

8.2 Prepare and install 2'-11 1/4" x 2'-11 1/4" glass into inner frame groove and fasten it by window beading from four sides. Use 1/2" galvanized nails.

8.3 Insert window into side wall openings and connect them with 8x2" wood screws to the wall beams.

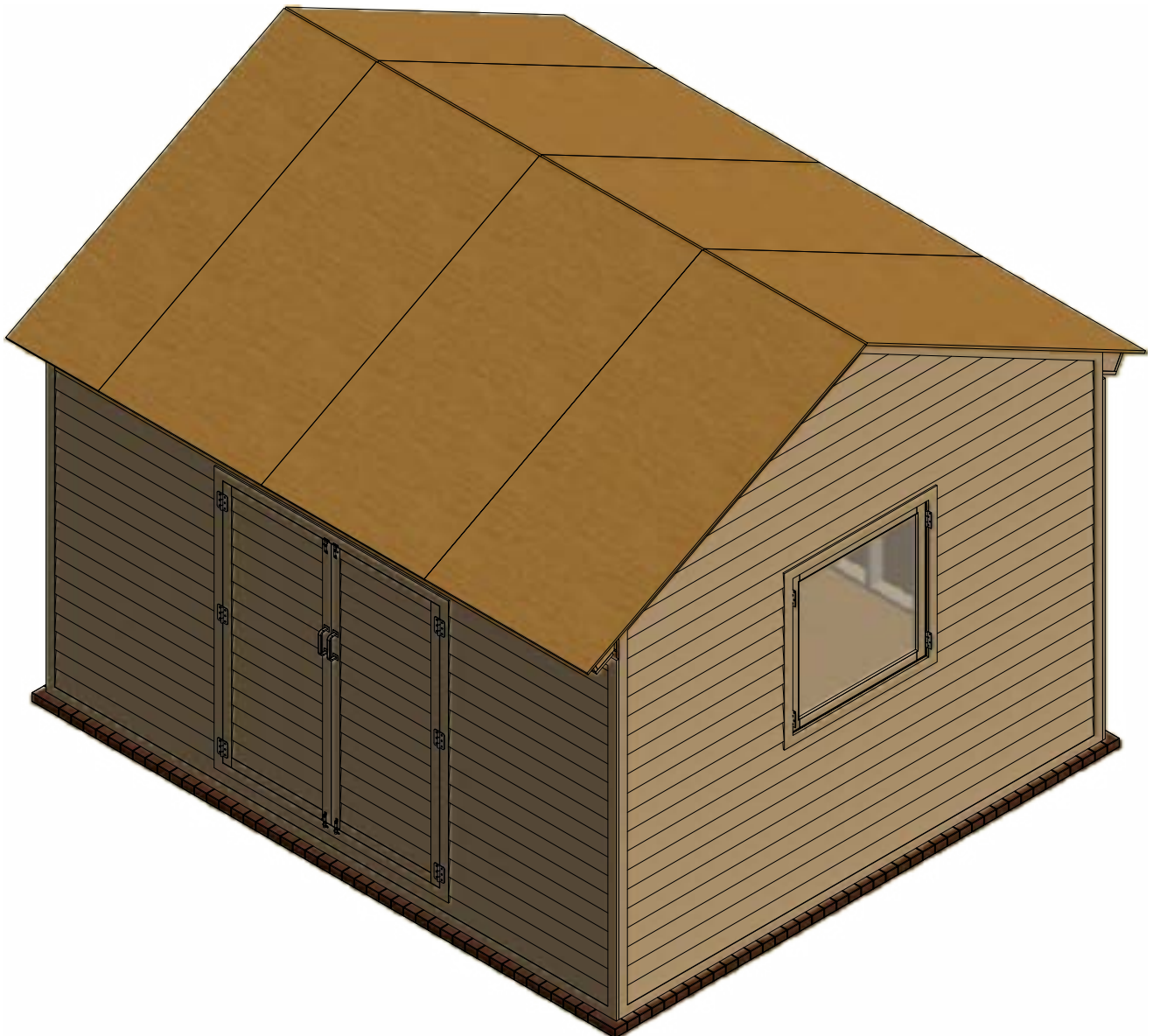

STEP 9

Roof Sheathing Installation

9.1 You will need 232 Sq Ft of building paper and asphalt shingle roofing.

9.2 Cover the plywood and drip edge with building paper. Try to install sheets with 1" overlapping. Use 2" nails to secure the sheets.

9.3 Install asphalt shingle roofing using an industrial stapler.

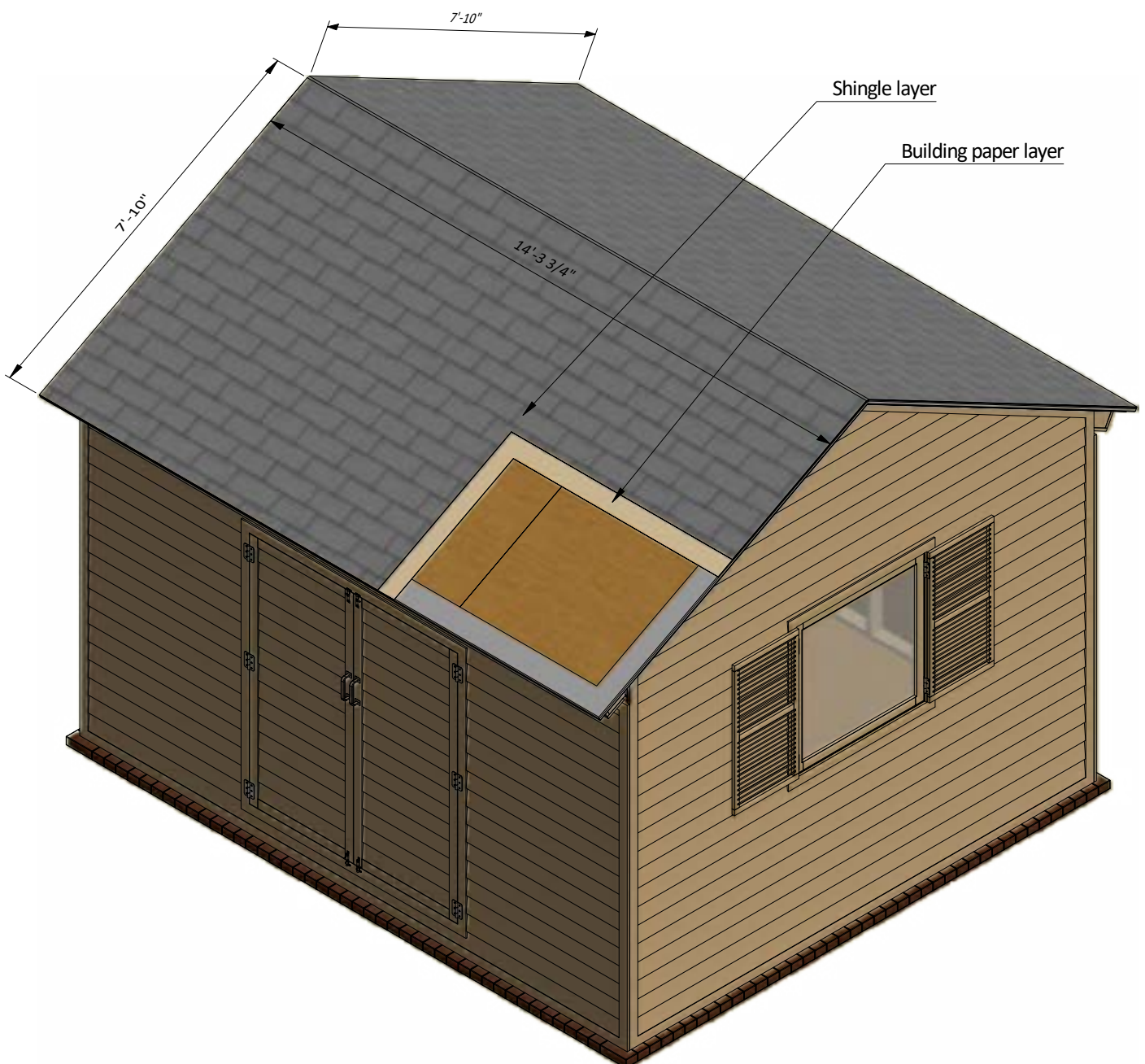

STEP 10

Assemble and Install Door Ramp

10.1 Using $3/4" \times 3\ 1/2"$, $3/4" \times 5"$, $1\ 1/2" \times 3\ 1/2"$ and $1\ 1/2" \times 7\ 1/4"$ pressure-treated lumber, construct door ramp using the drawing below as a reference. You will need five boards cut to $2'-9\ 1/2"$ that will be support girts, four boards cut to $1'-2\ 1/2"$ that will be joists (cut the top edge to fit the angle of support girts), one board cut to $5'-5\ 1/2"$ that will be rim joist and ten boards cut to $5'-5\ 1/2"$ that will be top sheathing.

10.2 Assemble siding shields with 2" and 3" galvanized nails.

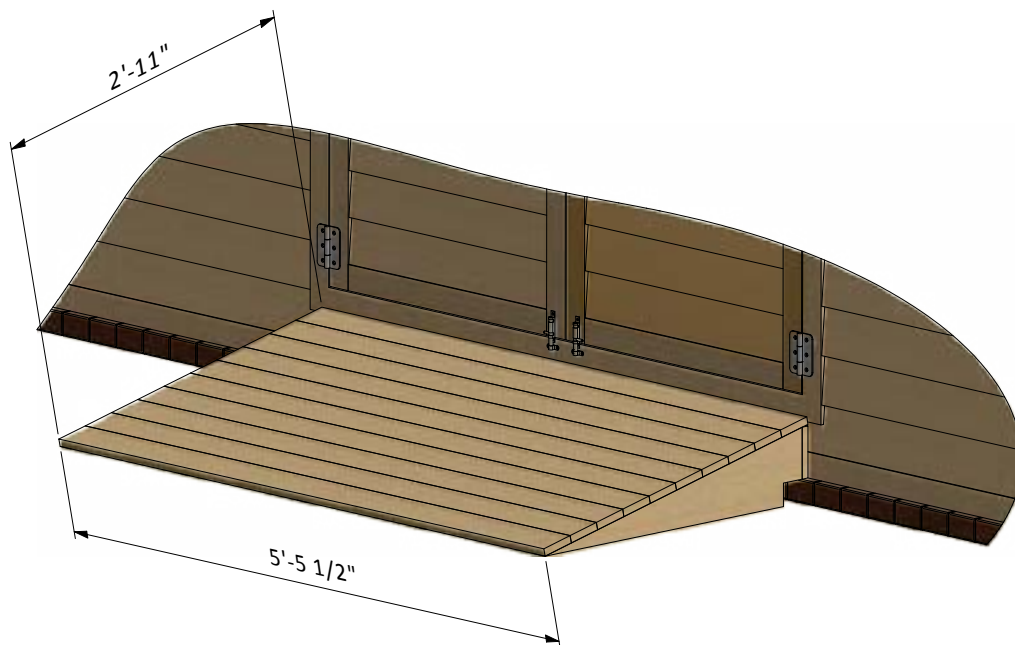

STEP 11

Assemble and Install Decorative Door Shutters

It is necessary to prepare two shutters.

11.1 Assemble front frame using 1 1/2" x 1 1/2" pressure-treated lumber and secure with 3" wood screws. You will need two boards cut to 6'-7" that will be the vertical girts and two boards cut to 1'-5 1/2" that will be the horizontal girts.

11.2 Assemble back frame using 3/4" x 2 1/2" pressure-treated lumber and secure with 5" wood screws. You will need two boards cut to 6'-7" that will be the vertical girts and two boards cut to 1'-3 1/2" that will be the horizontal girts.

11.3 Use 3/4" x 3/4" pressure-treated lumber for the lattice. You will need twenty four boards cut to 2'-1 1/2", four boards cut to 1'-7", four boards cut to 1' and four boards cut to 4'-3/4". Assemble according to the drawing.

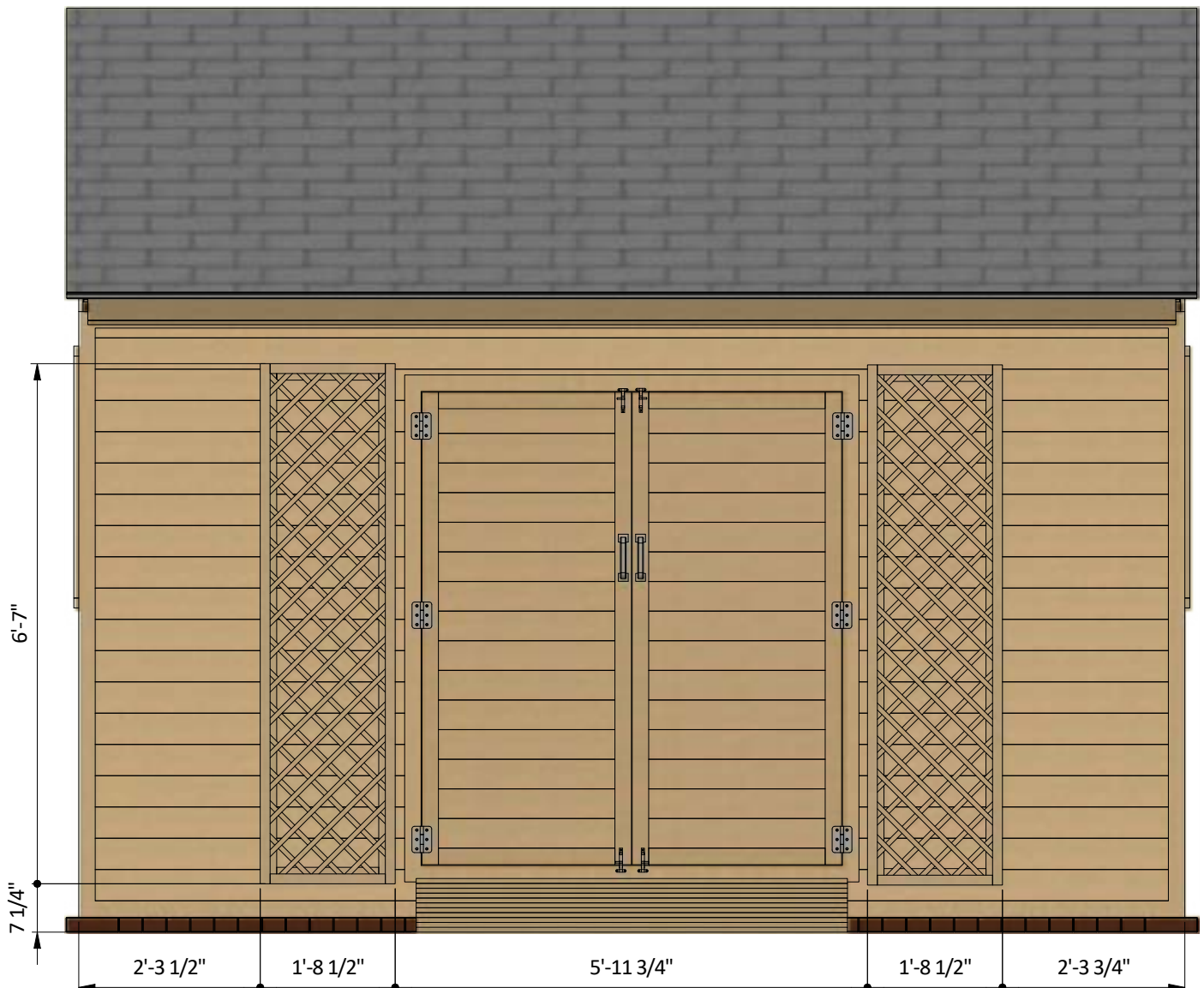

STEP 12

Thank You

Now that your shed is all done, you are ready to decorate it any way you want using your favorite paint, stain, or preservative.



Compare our Free vs. Premium plan

This perfectly designed plan will guide you through the entire process of building your very own shed for any backyard or garden.



Check out the benefits you would get with our **premium edition**:

Features	Free plan	Premium edition
Steps count	12	32
Illustrations for Each Step	✓	✓
Print Ready	✓	✓
Step By Step Instructions	✓	✓
Full Materials and Cuttings List	✗	✓
Additional Illustrations	✗	✓
Additional Blueprints	✗	✓
Tools List	✗	✓
Fastening Elements List	✗	✓
Technical Support	✗	✓

BUY NOW



For more great **HOW-TO** plans please visit: <https://shedplans.org>

Copyright

The text and illustrations that appear here are the exclusive property of shedplans.org and are protected by federal copyright laws. The duplication, sale or distribution of any portion of these plans without prior written consent from the original designer will be subject to the appropriate penalties for copyright infringement. Sharing this plan on the web is only permitted with an indicated original source: <https://shedplans.org>